

PQ20WZ51J00H

PQ20WZ11J00H

Variable Output, Surface Mount Type
Low Power-Loss Voltage Regulators

■ Features

1. Low power-loss
(Dropout voltage: MAX. 0.5V)
2. Surface mount package
3. Output current (0.5A: PQ20WZ51J00H)
(1.0A: PQ20WZ11J00H)
4. Reference voltage precision: $\pm 2.0\%$
5. Variable output voltage (3 to 20V)
6. Built-in ON/OFF control function
7. Low dissipation current at OFF-state (I_{qs} : MAX. 5 μ A)
8. Built-in overcurrent and overheat protection functions
9. RoHS directive compliant

■ Applications

1. Personal computers
2. CD-ROM drives
3. Power supplies for various OA equipment

■ Model Line-up

Output current (I_o)	Package type	Variable output
0.5A	Taping	PQ20WZ51J00H
	Sleeve	PQ20WZ51J00H
1A	Taping	PQ20WZ11J00H
	Sleeve	PQ20WZ11J00H

■ Outline Dimensions

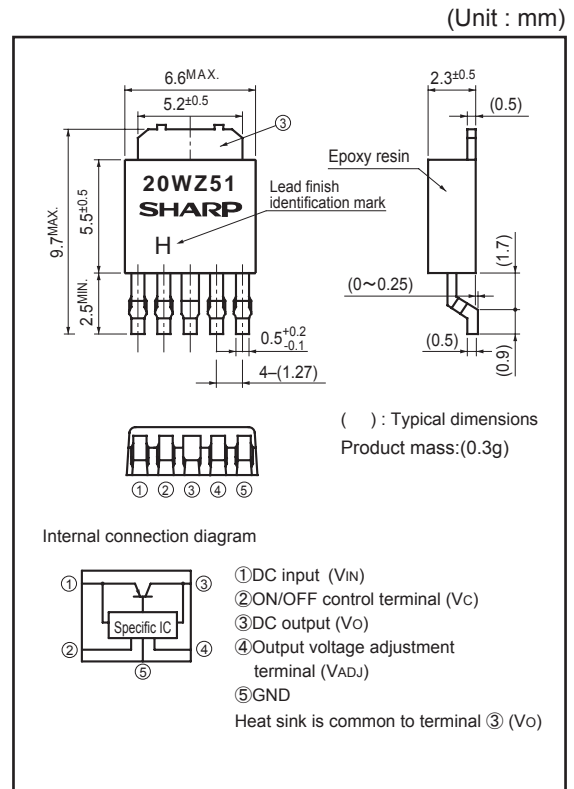

Lead finish: Lead-free solder plating
(Composition: Sn2Cu)

■ Absolute Maximum Ratings (Ta=25°C)

Parameter	Symbol	Rating	Unit	
*1 Input voltage	V_{IN}	24	V	
ON/OFF control terminal voltage	V_c	24	V	
*1 Output adjustment terminal voltage	V_{ADJ}	5	V	
Output current	I_o	PQ20WZ51J00H	0.5	A
		PQ20WZ11J00H	1	
*2 Power dissipation	P_D	8	W	
*3 Junction temperature	T_j	150	°C	
Operating temperature	T_{opr}	-20 to +80	°C	
Storage temperature	T_{stg}	-40 to +150	°C	
Soldering temperature	T_{sol}	260(10s)	°C	

*1 All are open except GND and applicable terminals.

*2 P_D : With infinite heat sink

*3 Overheat protection may operate at T_j : 125°C to 150°C

Notice The content of data sheet is subject to change without prior notice.

In the absence of confirmation by device specification sheets, SHARP takes no responsibility for any defects that may occur in equipment using any SHARP devices shown in catalogs, data books, etc. Contact SHARP in order to obtain the latest device specification sheets before using any SHARP device.

Electrical Characteristics

(Unless otherwise specified, condition shall be $V_{IN}=5V, V_O=3.3, ^{*4}, R_1=2k\Omega, R_2=500\Omega, V_C=2.7V, T_a=25^\circ C$)

Parameter	Symbol	Conditions	MIN.	TYP.	MAX.	Unit
Input voltage	V_{IN}	-	3.5	-	24	V
Output voltage	V_O	-	3.0	-	20	V
Load regulation	Reg_L	*5	-	-	2.0	%
Line regulation	Reg_L	$V_{IN}=4 \text{ to } 10V, I_O=5mA$	-	-	2.5	%
Ripple rejection	RR	Refer to Fig.2	45	60	-	dB
Reference voltage	V_{ref}	*4	2.574	2.64	2.706	V
Temperature coefficient of reference voltage	$T_C V_{ref}$	$T_j=0 \text{ to } +125^\circ C, I_O=5mA$	-	± 1.0	-	%
Dropout voltage	V_{I-O}	$^{*4}, ^{*6}$	-	-	0.5	V
Quiescent current	I_q	$I_O=0A$	-	-	8	mA
*7 ON-state voltage for control	$V_{C(ON)}$	-	2.0	-	-	V
ON-state current for control	$I_{C(ON)}$	-	-	-	200	μA
OFF-state voltage for control	$V_{C(OFF)}$	$I_O=0A$	-	-	0.8	V
OFF-state current for control	$I_{C(OFF)}$	$I_O=0A, V_C=0.4V$	-	-	2.0	μA
Output OFF-state consumption current	I_{qs}	$I_O=0A, V_C=0.4V$	-	-	5.0	μA

*4 PQ20WZ51J00H: $I_O=0.3A$, PQ20WZ11J00H: $I_O=0.5A$

*5 PQ20WZ51J00H: $I_O=5mA$ to $0.5A$, PQ20WZ11J00H: $I_O=5mA$ to $1.0A$

*6 Input voltage shall be the value when output voltage is 95% in comparison with the initial value.

*7 In case of opening control terminal ②, output voltage turns off.

Fig.1 Test Circuit

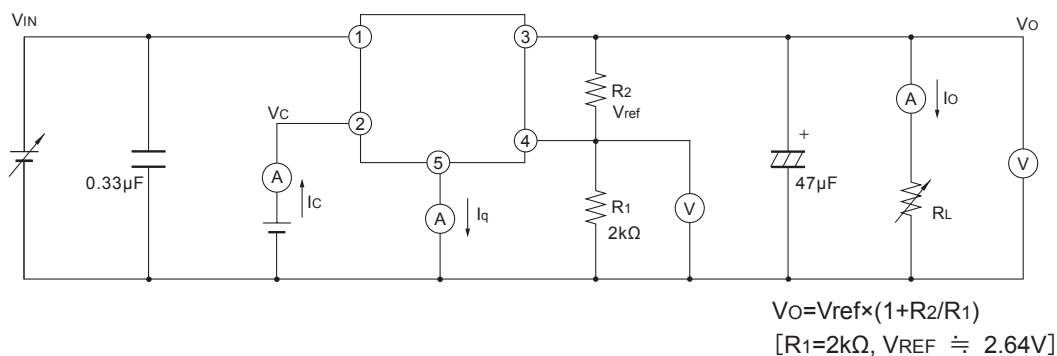

Fig.2 Test Circuit for Ripple Rejection

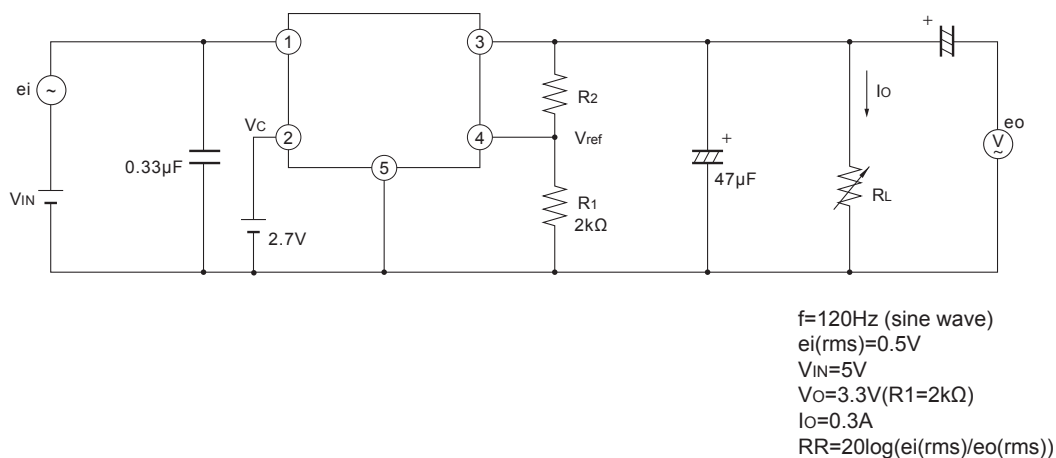
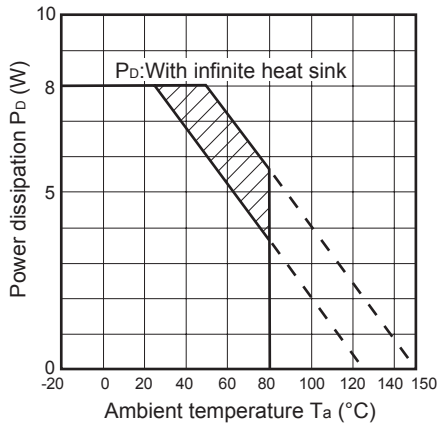

Fig.3 Power Dissipation vs. Ambient Temperature



Note) Oblique line portion: Overheat protection may operate in this area.

Fig.4 Overcurrent Protection Characteristics (Typical Value)(PQ20WZ51J00H)

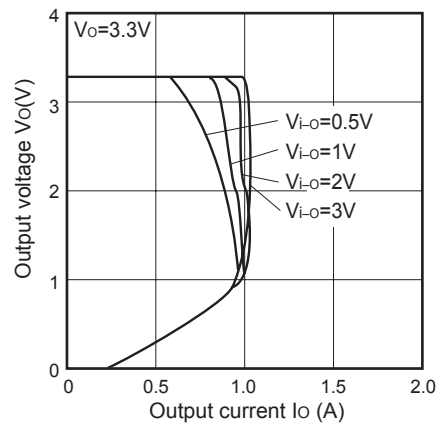

Fig.5 Overcurrent Protection Characteristics (Typical Value)(PQ20WZ11J00H)

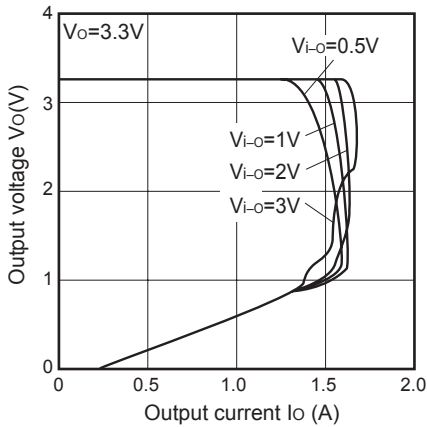

Fig.6 Output Voltage Adjustment Characteristics

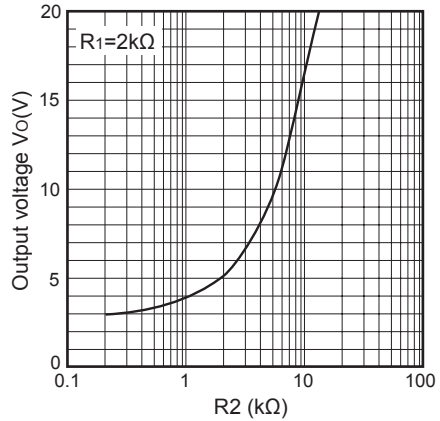

Fig.7 Reference Voltage Deviation vs. Junction Temperature (Typical Value)

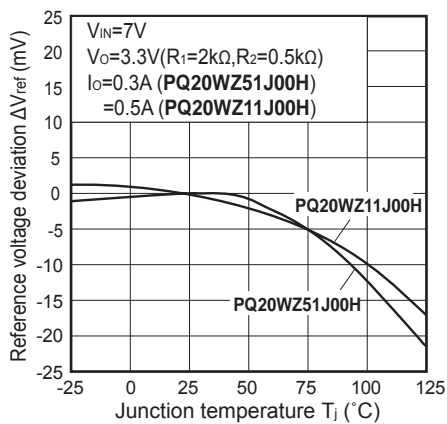

Fig.8 Output Voltage vs. Input Voltage (PQ20WZ51J00H)

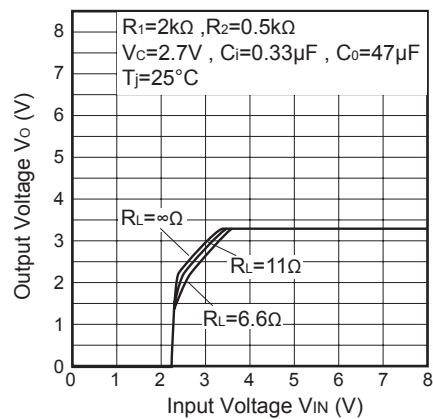

Fig.9 Output Voltage vs. Input Voltage (PQ20WZ11J00H)

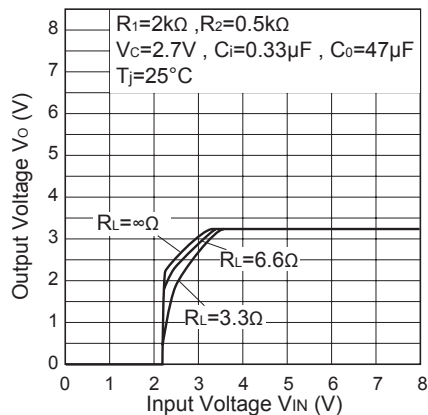

Fig.10 Dropout Voltage vs. Junction Temperature (PQ20WZ51J00H)

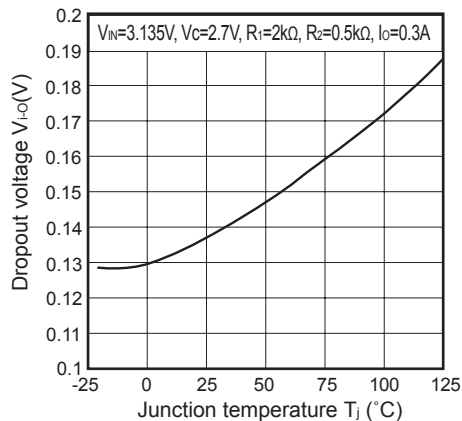

Fig.11 Dropout Voltage vs. Junction Temperature (PQ20WZ11J00H)

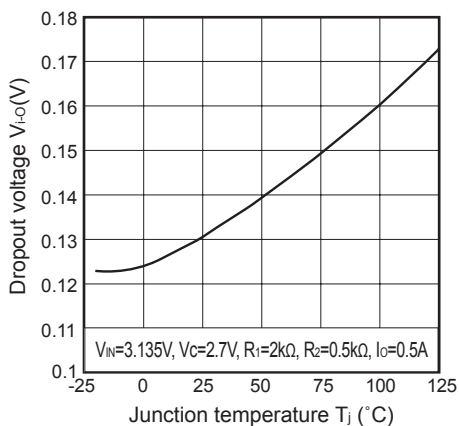

Fig.12 Quiescent Current vs. Junction Temperature

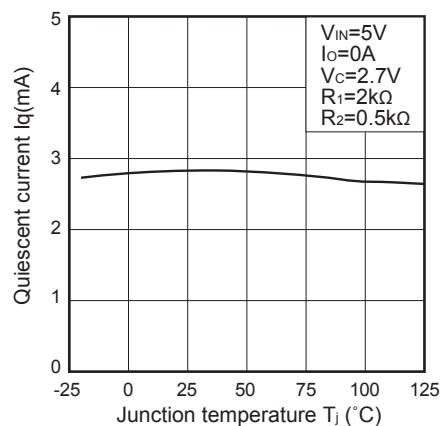

Fig.13 Ripple Rejection vs. Input Ripple Frequency

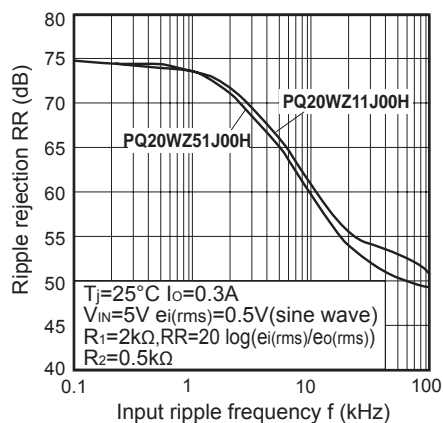

Fig.14 Ripple Rejection vs. Output Current (PQ20WZ51J00H)

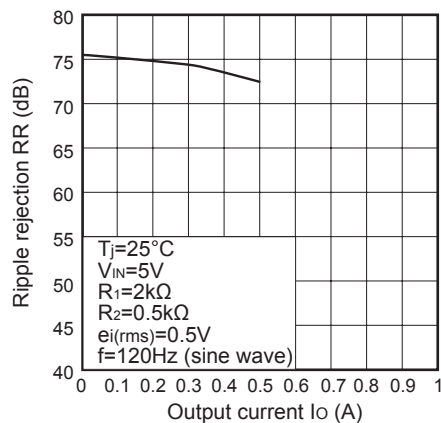

Fig.15 Ripple Rejection vs. Output Current (PQ20WZ11J00H)

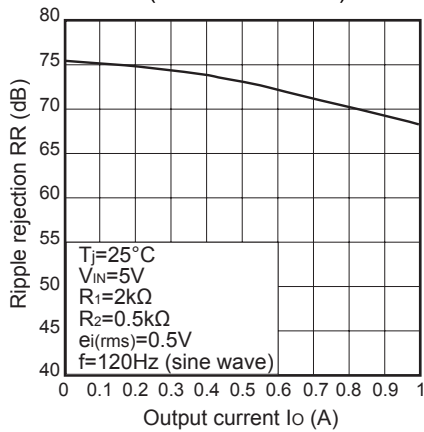

Fig.16 Circuit Operating Current vs. Input Voltage (PQ20WZ51J00H)

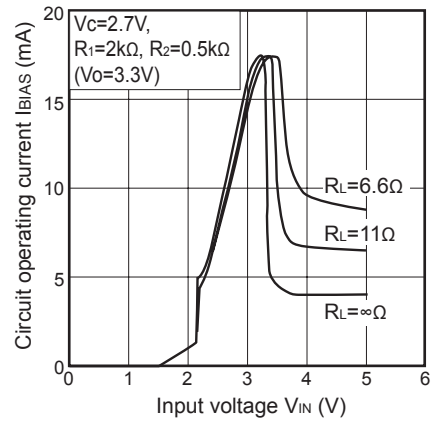

Fig.17 Circuit Operating Current vs. Input Voltage (PQ20WZ11J00H)

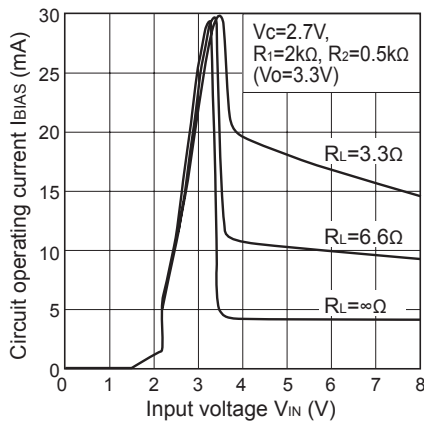
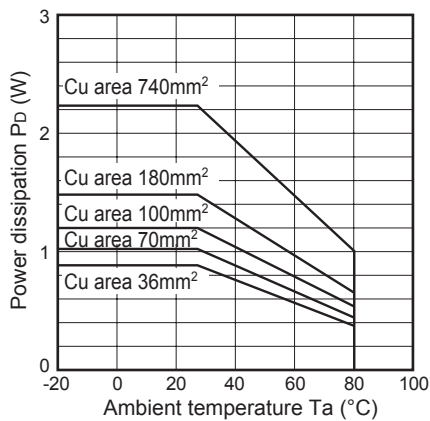
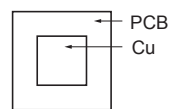

Fig.18 Power Dissipation vs. Ambient Temperature



Mounting PCB



Material : Glass-cloth epoxy resin
 Size : 50×50×1.6mm
 Cu thickness : 35μm

■ Setting of Output Voltage

Output voltage is able to set from 3V to 20V when resistors R₁ and R₂ are attached to ,③、④、⑤ terminals. As for the external resistors to set output voltage, refer to the figure below and Fig.6.

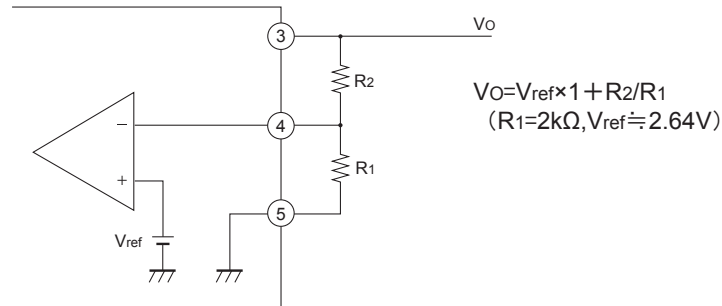

■ Typical Application

